

Case Study of Reader/Writer System

Moonzoo Kim
CS Dept. KAIST

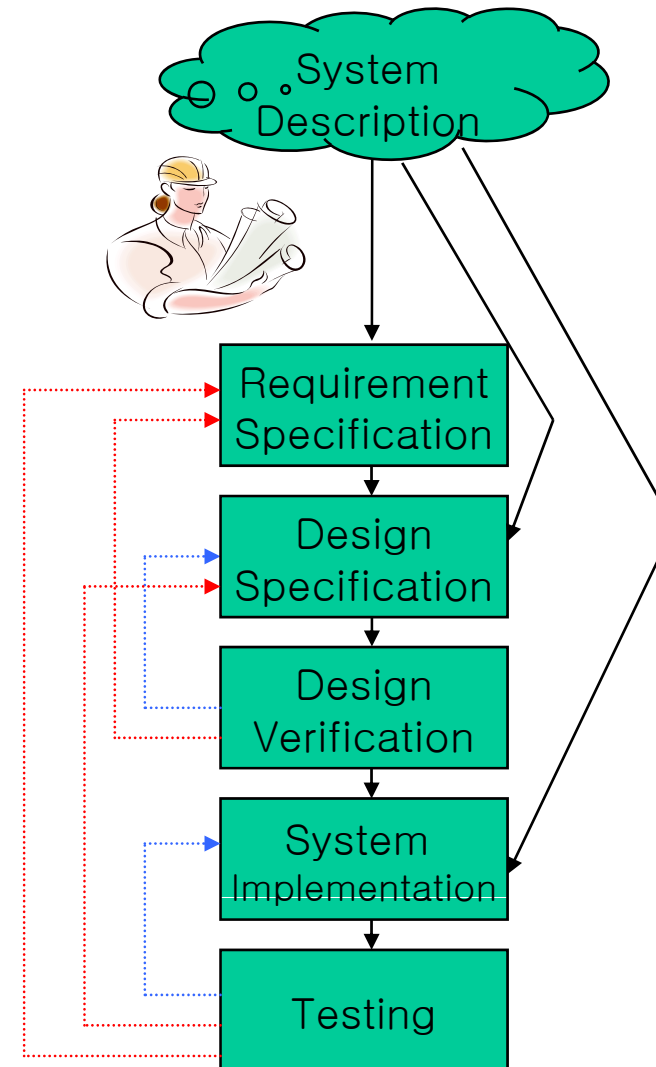

- System Description
- Formal Requirement Specification
- Formal Design Specification
- Formal Verification
- Testing



Multiple Reader/Writer System

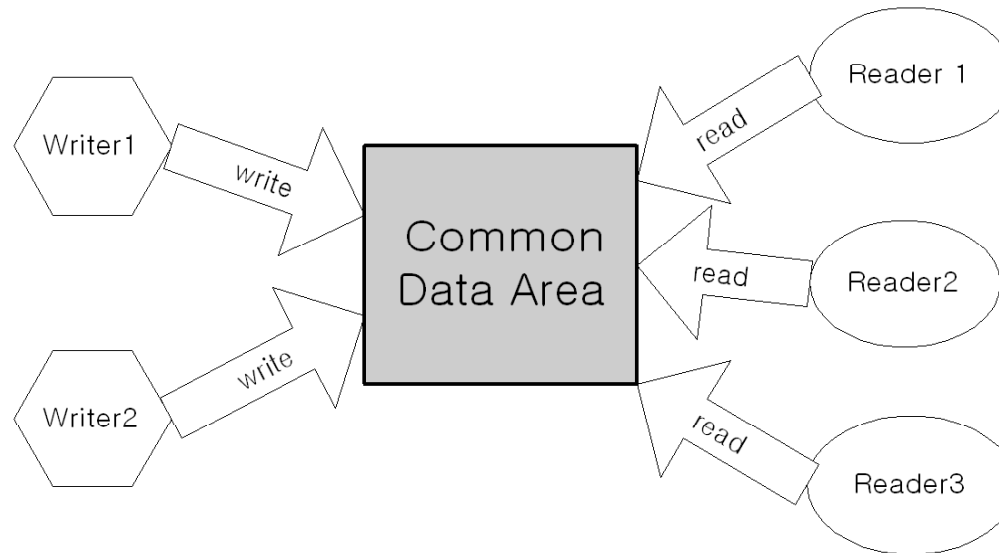

■ System requirement

- ✚ Concurrency (CON)
- ✚ Exclusive writing (EW)
- ✚ High priority of writer (HPW)



Formal Requirement Specification

■ 1 writer and 2 readers system

✚ Execution tree

✚ RW system has 9 events

- $\{ir1, rs1, re1, ir2, rs2, re2, ww, ws, we\}$

✚ A state $s = (n_{ir1}, n_{rs1}, n_{ir2}, n_{rs2}, n_{ww}, n_{ws})$

- $s0 = (0,0,0,0,0,0)$
- $s1 = (0,0,0,0,1,0)$
- $s11 = (1,0,0,0,1,0)$
- $s12 = (0,0,0,0,0,1)$

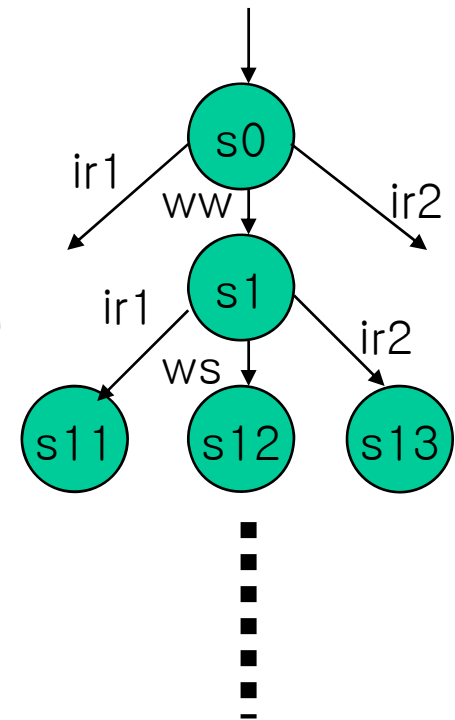

Valid execution paths

✚ Correct Event Ordering

- $n_{ir1}(s_i) \geq 0 \wedge n_{rs1}(s_i) \geq 0 \wedge n_{ir1}(s_i) + n_{rs1}(s_i) \leq 1$
- $n_{ir2}(s_i) \geq 0 \wedge n_{rs2}(s_i) \geq 0 \wedge n_{ir2}(s_i) + n_{rs2}(s_i) \leq 1$
- $n_{ww}(s_i) \geq 0 \wedge n_{ws}(s_i) \geq 0 \wedge n_{ww}(s_i) + n_{ws}(s_i) \leq 1$

✚ Exclusive Writing

- $n_{ws}(s_i) = 1 \rightarrow (n_{rs1}(s_i) = 0 \wedge n_{rs2}(s_i) = 0)$

✚ High Priority of Writer

- $(n_{ww}(s_i) = 1 \wedge n_{rs1}(s_i) = 0 \wedge n_{rs2}(s_i) = 0) \rightarrow (n_{rs1}(s_{i+1}) = 0 \wedge n_{rs2}(s_{i+1}) = 0)$

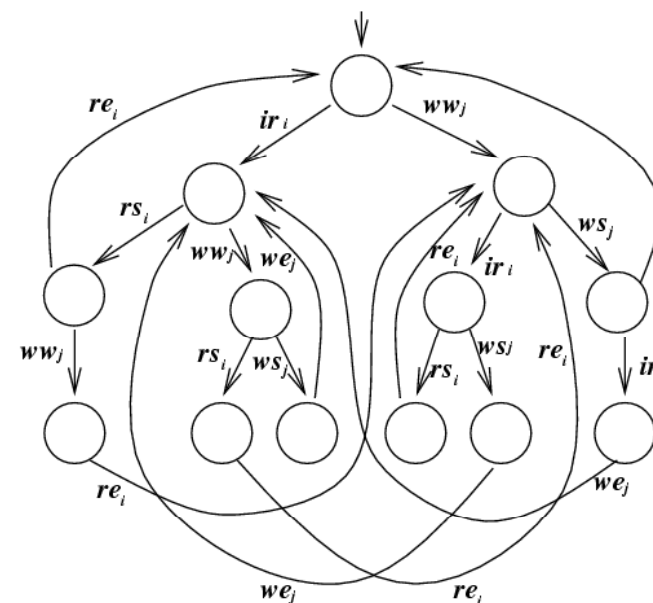
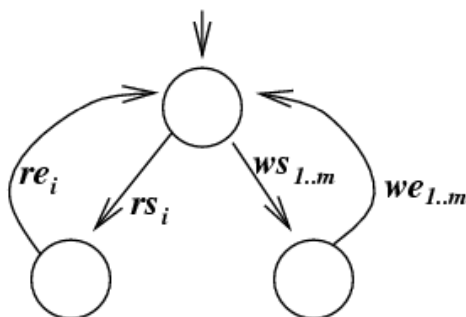
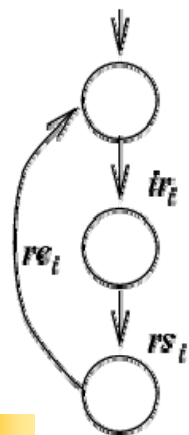

Formal Requirement Specification (cont.)

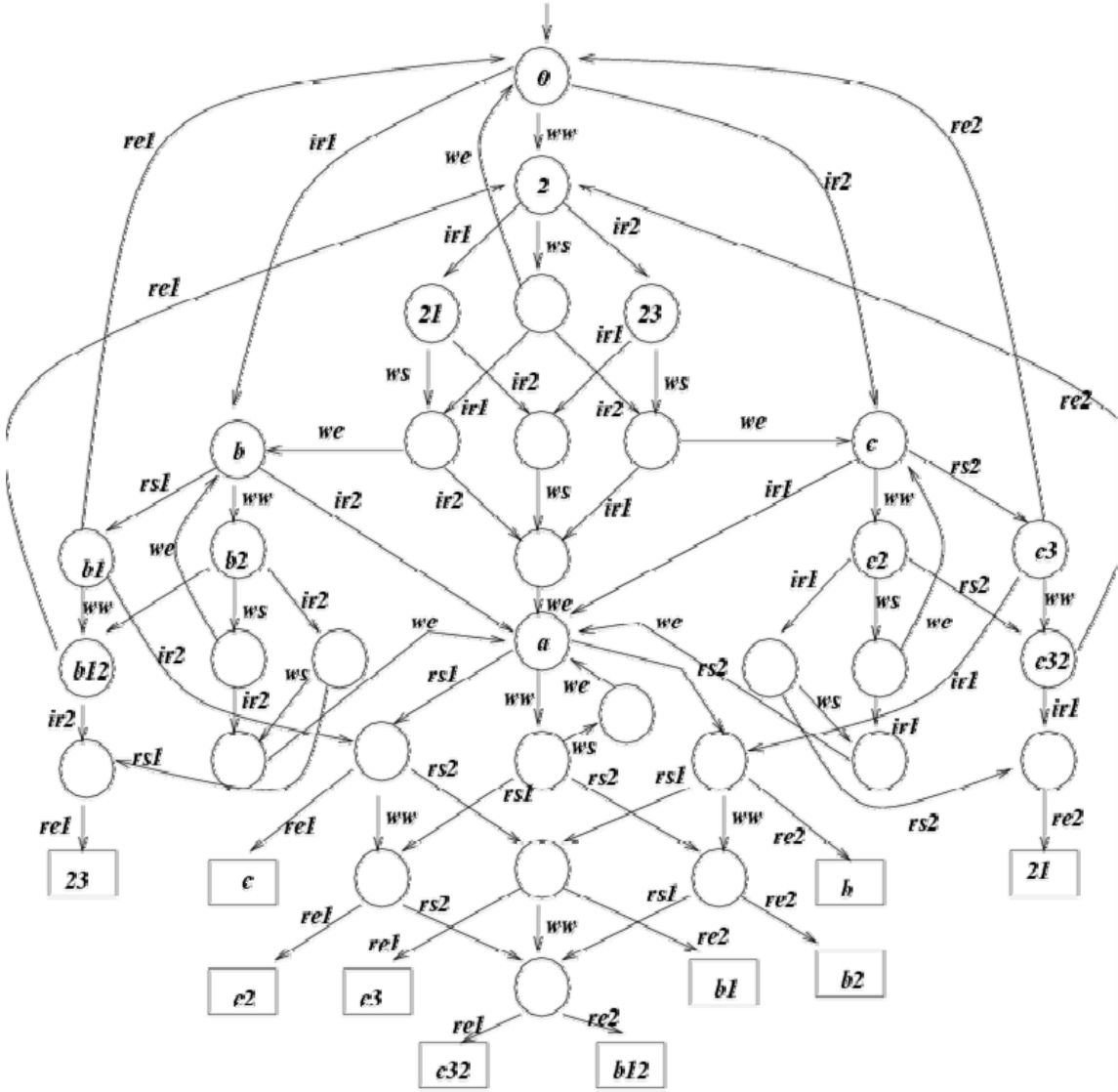

Formal Requirement Specification (cont.)

* Requirement Specification *

proc S0 = ir1.B + ww.S2 + ir2.C

proc S2 = ir1.S21 + ws.S22 + ir2.S23

proc S21 = ws.S212 + ir2.S213

proc S22 = ir1.S212 + we.S0 + ir2.S232

proc S23 = ir1.S213 + ws.S232

proc S212 = we.B + ir2.S2123

proc S213 = ws.S2123

proc S232 = ir1.S2123 + we.C

proc S2123 = we.A

proc A = rs1.A1 + ww.A2 + rs2.A3

proc A1 = re1.C + ww.A12 + rs2.A13

proc A2 = rs1.A12 + ws.we.A + rs2.A32

proc A3 = rs1.A13 + ww.A32 + re2.B

proc A12 = re1.C2 + rs2.A123

proc A13 = re1.C3 + ww.A123 + re2.B1

proc A32 = rs1.A123 + re2.B2

proc A123 = re1.C32 + re2.B12

proc B = rs1.B1 + ww.B2 + ir2.A

proc B1 = re1.S0 + ww.B12 + ir2.A1

proc B2 = rs1.B12 + ws.B22 + ir2.B23

proc B12 = re1.S2 + ir2.B123

proc B22 = we.B + ir2.B223

proc B23 = ws.B223 + rs1.B123

proc B123 = re1.S23

proc B223 = we.A

proc C = ir1.A + ww.C2 + rs2.C3

proc C2 = ir1.C21 + ws.C22 + rs2.C32

proc C3 = ir1.A3 + ww.C32 + re2.S0

proc C21 = ws.C221 + rs2.C321

proc C22 = ir1.C221 + we.C

proc C32 = ir1.C321 + re2.S2

proc C221 = we.A

proc C321 = re2.S21



Formal Design Specification

- RW system designed in “Concurrent Programming in Java[Lea99]”
- proc S =
(R1|R2|W|AR0|WW0|AW0|
LOCK|SLEEP0)\
{ dec_WW, inc_WW, dec_AW, inc_AW, ... }
proc R1 = ...
 - Processes (R1, R2, W, Lock, etc) communicate each other through signals (dec_WW, inc_WW, etc)
 - variables in RW code are represented as processes (AR0, AW0, etc)

```
class RW {  
    int activeReaders_ = 0;  
    int activeWriters_ = 0;  
    int waitingReaders_ = 0;  
    int waitingWriters_ = 0;  
  
    void read() {  
        beforeRead();  
        read_();  
        afterRead();  
    }  
  
    void beforeRead()      {...}  
    void read_()           {...}  
    void afterRead()       {...}  
    ...  
}
```



Testing using Formal Specification

- Insert probe into the RW source code
 - ✚ Probe generates event signal
- Testing RW code utilizing formal requirement spec as a test oracle
 - ✚ Use CWB-NC based simulation feature
 - ✚ Inappropriate event signal means violation

```
public abstract class RW{
    protected int activeReaders_ = 0;
    protected int activeWriters_ = 0;
    protected int waitingReaders_ = 0;
    protected int waitingWriters_ = 0;

    public void read(String id) {
        beforeRead();
        read_(id);
        afterRead();
    }
    protected synchronized void beforeRead(){
        Event("ir");...
    }
    public void read_() {
        Event("rs");...
    }
    protected synchronized void afterRead(){
        Event("re");...
    }
    ...
}
```



RW Java Code

```
public abstract class RW2 {
    protected int activeReaders_ = 0; //threads executing read_
    protected int activeWriters_ = 0; //always 0 or 1
    protected int waitingReaders_ = 0; //threads not yet in read_
    protected int waitingWriters_ = 0; //same for write_

    protected abstract void read_(String id);
    protected abstract void write_(String id);

    void Event(String s){ //System.out.println(s);}

    public void read(String id) {
        /*Event("ir" + id);*/ beforeRead();
        /*Event("rs" + id);*/ read_(id);
        /*Event("re" + id);*/ afterRead();
    }

    public void write(String id) {
        /*Event("ww");*/ beforeWrite();
        /*Event("ws");*/ write_(id);
        /*Event("we");*/ afterWrite();
    }

    protected boolean allowReader() {
        if (waitingWriters_ == 0 && activeWriters_ == 0) {
            return true;
        }
        else
            return false;
    }
}
```

```
protected boolean allowWriter() {
    if(activeReaders_ == 0 && activeWriters_ == 0) {
        return true;
    } else return false;
}

protected synchronized void beforeRead() {
    ++waitingReaders_;
    while(!allowReader())
        try{ wait();}
        catch(InterruptedException ex){}
    --waitingReaders_;
    ++activeReaders_;
}

protected synchronized void afterRead() {
    --activeReaders_;
    notifyAll();
}

protected synchronized void beforeWrite() {
    ++waitingWriters_;
    while(!allowWriter())
        try{wait();}
        catch(InterruptedException ex){}
    --waitingWriters_;
    ++activeWriters_;
}

protected synchronized void afterWrite() {
    --activeWriters_;
    notifyAll();
}
}
```



RW System Design

```
*****
* RW system description of 2 Readers and 1 Writer *
*****
proc S = (R1|R2|W|AR0|WW0|AW0|LOCK|SLEEP0)\
    {dec_WW, inc_WW, dec_AW, inc_AW, dec_AR, inc_AR,
     zero_WW, zero_AW, zero_AR, non_zero_WW, non_zero_AW,
     non_zero_AR, lock, unlock,
     zero_sleep, one_sleep, two_sleep, dec_sleep, inc_sleep,
     wake_up}

proc WW0 = zero_WW.WW0 + inc_WW.WW1
proc WW1 = dec_WW.WW0 + non_zero_WW.WW1

proc AW0 = zero_AW.AW0 + inc_AW.AW1
proc AW1 = dec_AW.AW0 + non_zero_AW.AW1

proc AR0 = zero_AR.AR0 + inc_AR.AR1
proc AR1 = dec_AR.AR0 + inc_AR.AR2
           + non_zero_AR.AR1
proc AR2 = dec_AR.AR1 + non_zero_AR.AR2

proc SLEEP0 = zero_sleep.SLEEP0 + inc_sleep.SLEEP1
proc SLEEP1 = one_sleep.SLEEP1 + inc_sleep.SLEEP2 + dec_sleep.SLEEP0
proc SLEEP2 = two_sleep.SLEEP2 + dec_sleep.SLEEP1

proc R1 = 'lock.ir1.
    ( 'zero_WW.
      ('zero_AW.'inc_AR.'unlock.READ1
       + 'non_zero_AW.'inc_sleep.'unlock.R1')
      + 'non_zero_WW.'inc_sleep.'unlock.R1')
proc R1' = wake_up.'lock.
    ( 'zero_WW.
      ('zero_AW.'inc_AR.'unlock.READ1
       + 'non_zero_AW.'inc_sleep.'unlock.R1')
      + 'non_zero_WW.'inc_sleep.'unlock.R1')
```

```
proc R2 = 'lock.ir2.
    ( 'zero_WW.
      ('zero_AW.'inc_AR.'unlock.READ2
       + 'non_zero_AW.'inc_sleep.'unlock.R2')
      + 'non_zero_WW.'inc_sleep.'unlock.R2')
proc R2' = wake_up.'lock.
    ( 'zero_WW.
      ('zero_AW.'inc_AR.'unlock.READ2
       + 'non_zero_AW.'inc_sleep.'unlock.R2')
      + 'non_zero_WW.'inc_sleep.'unlock.R2')

proc W = 'lock.ww.'inc_WW.
    ( 'zero_AR.
      ('zero_AW.'dec_WW.'inc_AW.'unlock.WRITE
       + 'non_zero_AW.'inc_sleep.'unlock.W')
      + 'non_zero_AR.'inc_sleep.'unlock.W')
proc W' = wake_up.'lock.
    ( 'zero_AR.
      ('zero_AW.'dec_WW.'inc_AW.'unlock.WRITE
       + 'non_zero_AW.'inc_sleep.'unlock.W')
      + 'non_zero_AR.'inc_sleep.'unlock.W')

proc READ1 = rs1.re1.'lock.'dec_AR.
    ('zero_sleep.'unlock.R1 +
     'one_sleep.'wake_up.'dec_sleep.'unlock.R1 +
     'two_sleep.'wake_up.'dec_sleep.'wake_up.'dec_sleep.'unlock.R1)
proc READ2 = rs2.re2.'lock.'dec_AR.
    ('zero_sleep.'unlock.R2+
     'one_sleep.'wake_up.'dec_sleep.'unlock.R2+
     'two_sleep.'wake_up.'dec_sleep.'wake_up.'dec_sleep.'unlock.R2)
proc WRITE = ws.we.'lock.'dec_AW.
    ('zero_sleep.'unlock.W +
     'one_sleep.'wake_up.'dec_sleep.'unlock.W +
     'two_sleep.'wake_up.'dec_sleep.'wake_up.'dec_sleep.'unlock.W)

proc LOCK = lock.unlock.LOCK
```



■ May preorder (classical trace inclusion)

✚ $P \leq_{\text{may}} Q$ iff on $T'(P) \subseteq T'(Q)$

- Ex. le –S may “a.nil” “a.b.nil”
 - Since $T'(a.nil) = \{a\}$, $T'(a.b.nil) = \{a,b\}$
 - But **not** le –S may “a.b.nil” “a.nil”



Formal Verification Result

```
01:cwb-nc> le -S may S S0
02:Building automaton...
03:States: 620
04:Transitions: 1016
05:Done building automaton.
06:Building automaton...
07:States: 34
08:Transitions: 75
09:Done building automaton.
10:Transforming automaton...
11:Done transforming automaton
12:TRUE
13:cwb-nc>
```

```
01: cwb-nc> le -S may S0 S
02: Building automaton...
03: States: 34
04: Transitions: 75
05: Done building automaton.
06: Building automaton...
07: States: 620
08: Transitions: 1016
09: Done building automaton.
10: Transforming automaton...
11: Done transforming automaton.
12: FALSE...
13: S0 has trace:
14:     irl ww ws
15: S does not.
16: cwb-nc>
```



Homework #1: Due Oct 7

- Draw LTS diagrams of Sys (two-way buffer, slide 12 of Sep 9th lecture) with proofs for all transitions. Also specify which two actions make τ (i.e. (b_-, b_-') or (b_+, b_+'))
- Simplify Sys specification (faulty mutual exclusion in slide 8 of Sep 11th lecture) by using relabelling functions
 - ✚ Show that your simplification is valid (i.e. by using CWB-NC)
- Specify Peterson's mutual exclusion protocol for 2 processes and verify its correctness using CWB-NC

```
/* Peterson's solution to the mutual exclusion problem - 1981 */
boolean turn, flag[2];
byte ncrit;
active [2] proctype user(){ /* two concurrent processors created */
again:  flag[_pid] = 1;
        turn = _pid;
        while(!(flag[1 - _pid] == 0 || turn == 1 - _pid));

        ncrit++;
        assert(ncrit == 1);      /* critical section */
        ncrit--;

        flag[_pid] = 0;
        goto again;
}
```

